



WirelessHART® Toxic & Combustible Gas Detector P/N: TCD60HXY

Installation and Maintenance Instructions



WirelessHART™



UNITED ELECTRIC
CONTROLS

LEADERS IN SAFETY, ALARM & SHUTDOWN

IM_TCD60-01
11/05/2021

United Electric Controls provides these installation and maintenance instructions for the UE Vanguard WirelessHART toxic & combustible gas detector solely. The end-user is responsible for maintaining the Vanguard WirelessHART toxic & combustible gas detector in full, operational condition. All warnings must be thoroughly read, understood and followed.

Misuse of this device and failure to adhere to all warnings could result in:

- the device not performing as intended,
- risk of explosion,
- risk of losing consciousness or death.

The following symbols are used within this document:



International Hazard Warning symbol. Directions require strict adherence.



International Toxic Hazard symbol. Exposure may lead to loss of consciousness or death.



International Flammable Material Hazard symbol. Exposure to flammable materials in closed areas may lead to explosion, loss of consciousness or death.

United Electric Controls reserves the right to change published specifications and designs without prior notice.

United Electric Controls Co.
180 Dexter Avenue
Watertown, MA
02472, USA
Telephone: +1 617 926-1000
Fax: +1 617 926-2568
Email: InsideSales@UEonline.com
Web: www.UEonline.com













Table of Contents

1.0 General	
1.1 Device Overview.....	1-2
1.2 Device Packaging.....	3
1.3 Device Approvals.....	4-5
2.0 Installation	
2.1 Battery Installation.....	6-7
2.2 Sensor Installation.....	8-9
2.3 Sensor Placement Considerations.....	9-10
2.4 Sensor Cross Sensitivity.....	10
2.5 Classified Area Installation.....	11
2.6 Field Mounting.....	11-16
2.7 Antenna Placement Considerations.....	17
2.8 Network Configuration.....	17-20
3.0 Operation	
3.1 Normal Operation.....	21
3.2 Sensor Calibration & Bump Test.....	22-24
3.3 Programming Mode.....	25-29
4.0 Field Replacement	
4.1 Sensor Replacement.....	30
4.2 Battery Replacement.....	31
5.0 Troubleshooting Guide	
5.1 Hardware.....	32
5.2 Wireless Communication.....	33
6.0 Dimensional Drawings.....	34
7.0 Appendix	
7.1 List of Figures.....	35
7.2 List of Tables.....	36
7.3 List of Graphs.....	36
7.4 List of Device Warnings (French Language).....	37-40

Please read all instructional literature carefully and thoroughly before starting

1.0 GENERAL

-  This device is for monitoring and communicating gas concentration levels for data collection or record keeping and does not provide alarm signals.
-  Misuse of this device may cause explosion and/or personal injury. These instructions must be thoroughly read and understood prior to installation of the device.
-  The end-user is responsible for maintaining the device in full, operational condition.
-  To ensure proper ingress protection, the front and rear covers must be installed, and fully bottomed out against the base enclosure (i.e., metal-to-metal contact). It is recommended to use a wrench or any tool across the cover lugs to tighten the covers down.
-   Exposure to toxic gas may result in loss of consciousness or death. See Annex 1 for toxic gas sensor details.
-   Combustible gas accumulation in closed areas may cause explosion, and result in loss of consciousness or death. See Annex 1 for combustible gas sensor details.
-  Avoid dropping the device as loosening of the threaded flame-proof joints or permanent damage may occur.
-  New sensors must be calibrated after installation (see Section 3.2).
-  When not in use, the device should be stored in a clean, dry area and within the temperature range listed within the device's environmental specifications.

1.1 Device Overview

The device is an explosion-proof and intrinsically safe, WirelessHART point gas detector used for the detection and monitoring of harmful gases in air, in order to help maintain a safe environment. A field-interchangeable gas sensor module (see Figure 1) provides detection of toxic or combustible gas. Gas measurement readings are communicated along with network and battery status (see Figure 2) via a local, digital display, and WirelessHART 7.2 communication protocol. The device seamlessly integrates with existing supervisory control and data acquisition (SCADA) or asset management (AMS) systems.

Sensor specifications are available online or in Annex 1 which can be downloaded from www.ueonline.com/vanguard.

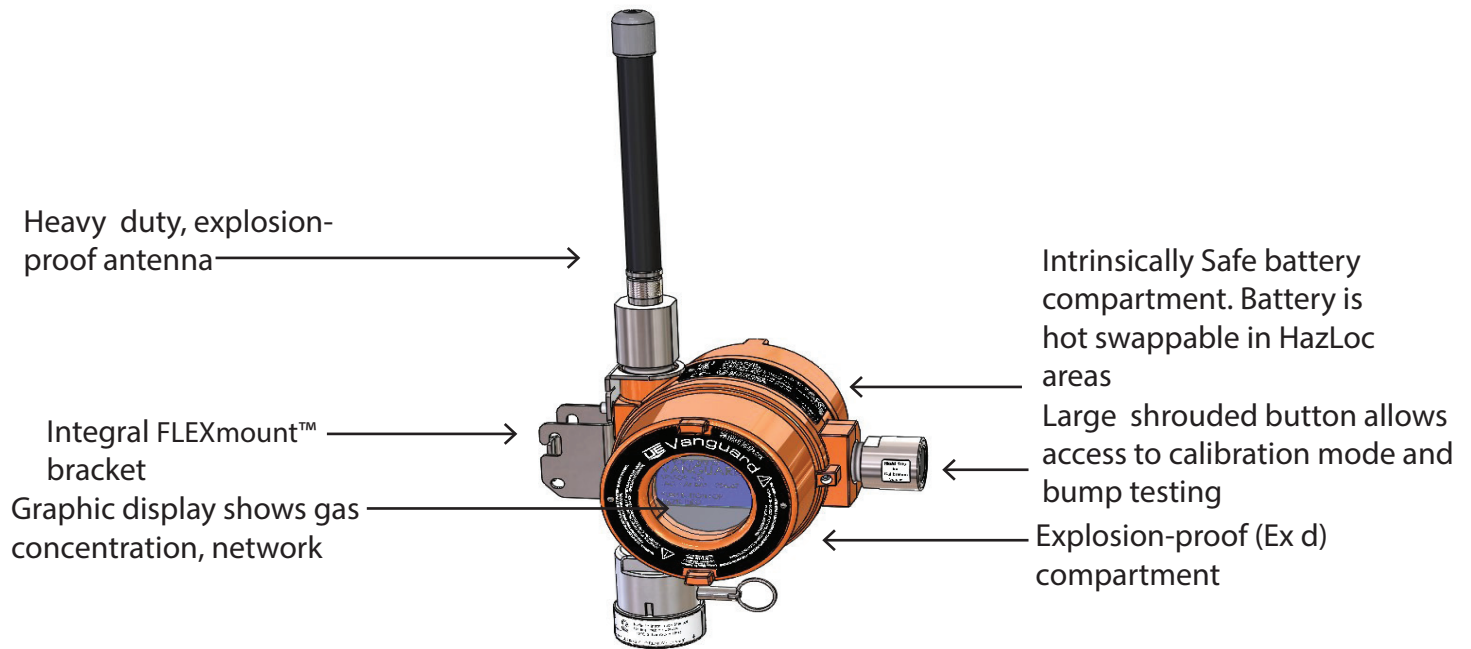

Figure 1

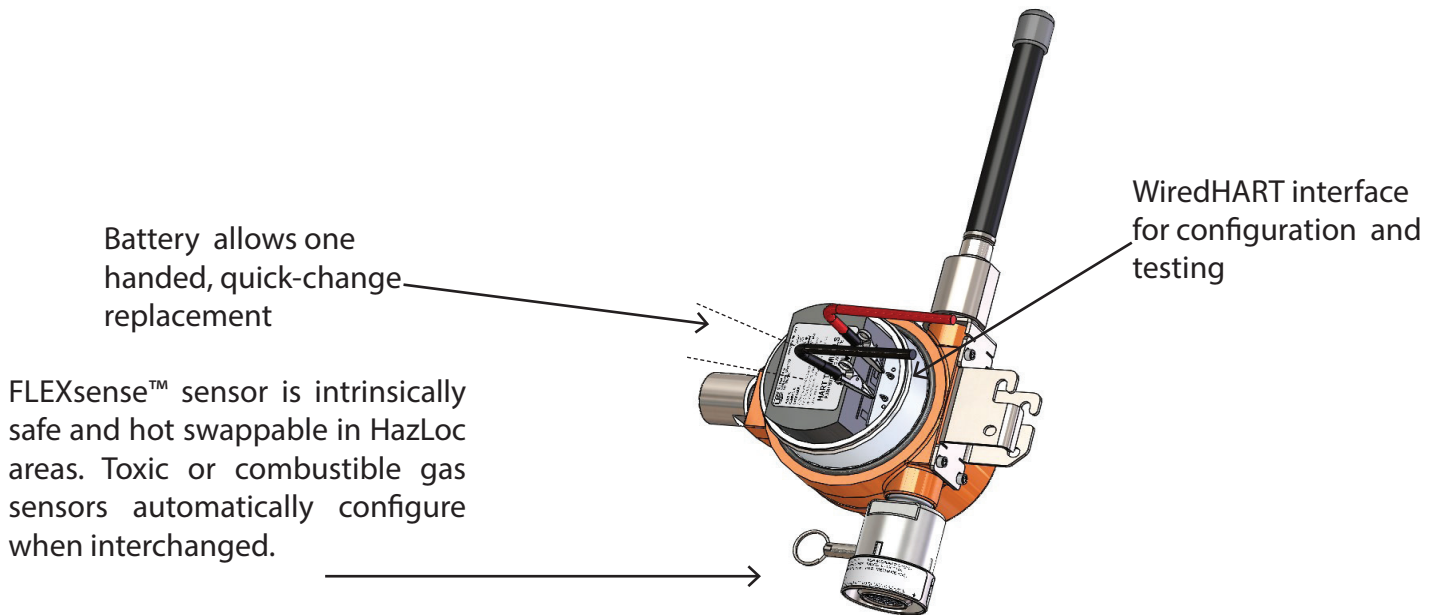



Figure 2

1.2 Device Packaging

The device may be shipped in one of the following two configurations. Please ensure that all items have been received before proceeding with installation and operation.

1. Base unit and mounting bracket kit with toxic or combustible FLEXsense™ sensor (Figure 3 and Figure 4).
2. Base unit and mounting bracket kit only (Figure 3 without sensor and Figure 4).

 Device is shipped without the sensor or battery installed. Both must be installed prior to use. See Section 2.0 Installation for further information.

1.2.1 Sensors

One FLEXsense™ sensor is shipped (but uninstalled) with the base unit (if ordered in that configuration). Additional, spare FLEXsense™ sensors may be ordered and will ship separately.

1.2.2 Battery

The battery pack is shipped separately from the base unit as it contains lithium which is regulated in transportation by the U.S. Department of Transportation, the International Air Transport Association, International Civil Aviation Organization, and European Ground Transportation of Dangerous Goods.

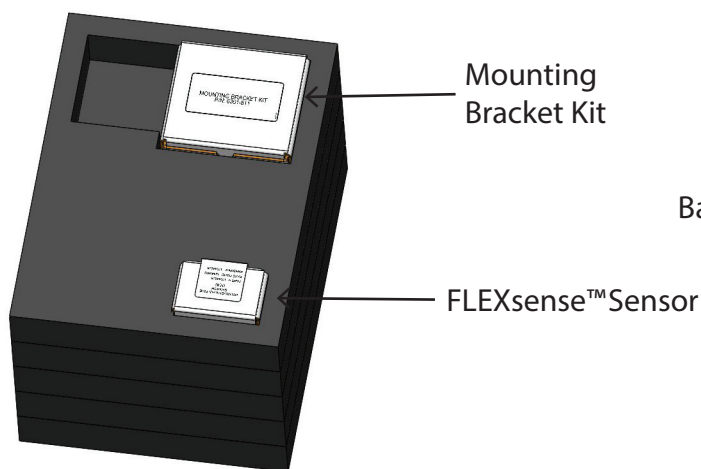

Top foam for packaging

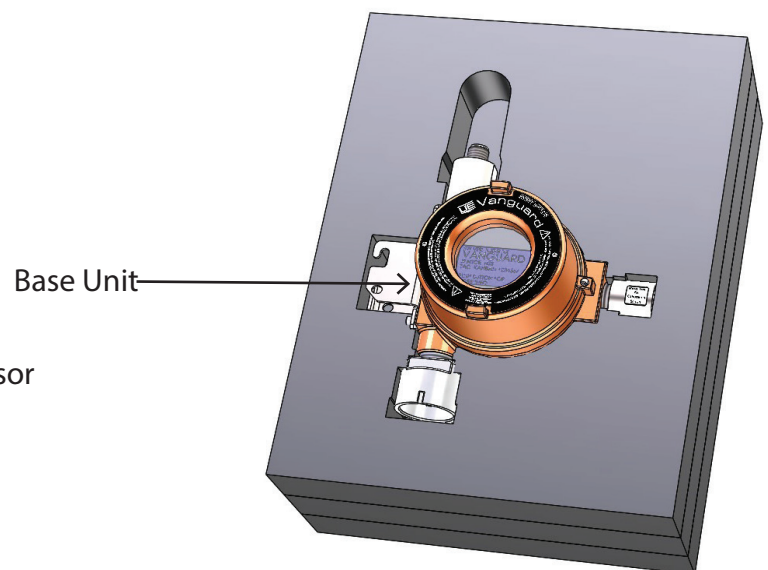

Figure 3





Bottom foam for packaging

Figure 4

1.3 Device Approvals

  This device is suitable for Class I, Divisions 1 & 2, Groups A,B,C,D; or non-hazardous locations only. $-40^{\circ}\text{C} (-40^{\circ}\text{F}) \leq T_{\text{amb}} \leq 65^{\circ}\text{C} (149^{\circ}\text{F})^*$. Type 4X and IP66**.

 This product is ATEX and IECEx certified for equipment category 2. Suitable for appropriate use in gas zone 1.

 The only field replaceable parts are the battery pack and FLEXsense™ sensor. Any substitution of components other than the battery and gas sensor module will invalidate third-party issued approvals and certifications, and may impair suitability for Class I, Division 1 location.



Global Certification
IECEX ETL 21.0065X
Ex db ia [ia] IIC T4 Gb
 $-40^{\circ}\text{C} \leq T_{\text{amb}} \leq +65^{\circ}\text{C}^*$



EU Certification
II 2 (2) G Ex db ia [ia] IIC T4 Gb
ITS-I21ATEX31360X
 $-40^{\circ}\text{C} \leq T_{\text{amb}} \leq +65^{\circ}\text{C}^*$



North American Certification
Class I Div. 1, Groups A,B,C,D, T4

USA: Class I, Zone 1, AEx db ia [ia] IIC T4 Gb
Enclosure Type 4X, IP66**

Canada: Class I, Zone 1, Ex db ia [ia] IIC T4 Gb
ETL21CA104546645X
 $-40^{\circ}\text{C} \leq T_{\text{amb}} \leq +65^{\circ}\text{C}^*$

*Ambient operating temperature range may vary with sensor type. See Technical Brochure for sensor specifications.

**Enclosure Type 4X and IP66 rating excludes sensor.



UE declarations and third-party issued agency certifications are available for download at: www.ueonline.com/prod_approval.

The device has been certified in accordance with the applicable requirements of the following standards:

Each certificate lists the standard, along with standard revision or date, which this Vanguard product meets. See DEMKO 11 ATEX 1105261X for EN Standards, See IECEx UL 14.0075X for IECEx Standards. The North America, ATEX (Europe), and IEC (International) certificates are available for download on the UE website: www.ueonline.com/prod_approval

2.0 INSTALLATION

2.1 Battery Installation

-  Only battery packs provided by United Electric Controls are compatible with this device.
-  Battery should be removed and stored when the device is not in use.
-  Batteries are not rechargeable.

The battery pack contains two Lithium-Thionyl Chloride D size cells, with a nominal output voltage of 7.2V.

1. Unscrew the solid, back cover from the intrinsically safe battery compartment and set aside.
2. Remove the battery pack from its packaging.
3. Align battery pack so connection on the pack lines up with connection in the enclosure.
4. Slide the battery pack into the enclosure until it latches in place as shown in Figure 5.

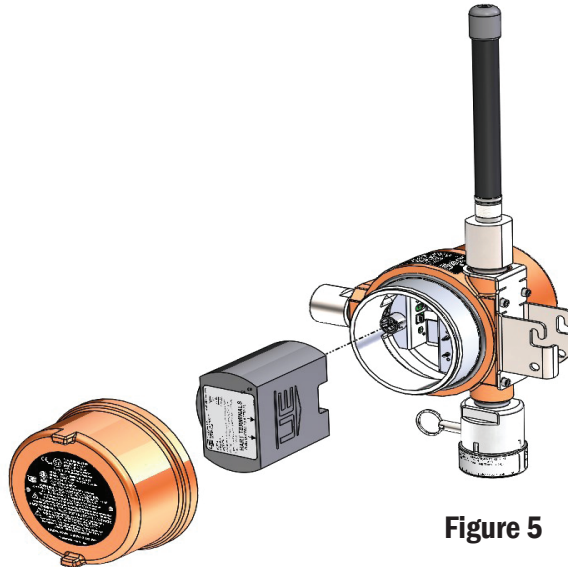

Figure 5

5. The device is now powered and will show the word **STARTING** along with the hardware and software versions on the front panel display while initial boot-up completes (see Figure 6).



Figure 6

- When hardware and software boot-up is complete, the device will prompt user to activate the installed sensor (see Figure 7)

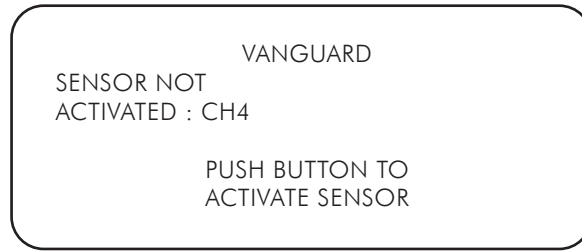

Figure 7

Refer to section 2.2 for sensor activation sequence.

- Once activation is done, the front panel display will display the device name, HART long tag, and the software version, along with an instruction to push button to show gas concentration (see Figure 8).

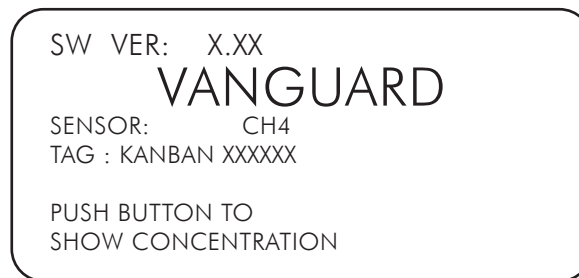





Figure 8

- The device is now ready to be configured for deployment into a WirelessHart network. It is recommended to connect the device to the network immediately after battery installation to maximize battery life. Refer to section 2.8 for network configuration.
- Once device configuration is complete, secure cover onto enclosure by tightening until all threads have been fully engaged to ensure proper ingress protection.*

*NOTE: To ensure proper ingress protection, the rear cover must be installed, and fully bottomed out against the base enclosure (i.e., metal-to-metal contact). It is recommended to use a wrench or any tool across the cover lugs to tighten the covers down.

2.2 Sensor Installation

-  Only FLEXsense™ sensors provided by United Electric Controls are compatible with this device.
-  Do not attempt to disassemble the sensor as this could damage the sensor and void hazardous location approvals, and manufacturer warranty.
-  Sensors must be activated after installation.
-  Ensure base unit has a sensor installed at all times when mounted outdoors to prevent damage to connectors due to ambient moisture.

Sensors are packaged fully assembled and require simple installation into the base unit. Toxic sensors are comprised of an electrochemical sensor packaged into a stainless steel housing. Combustible sensors are comprised of an infrared sensor packaged into a stainless steel housing. These are consumable, field replaceable parts (see Section 4.1, Sensor Replacement).

1. Remove FLEXsense™ sensor from packaging.
2. Retract the sensor locking pin and twist 90 degrees to lock in retracted position.
3. Align the locating pins (see Figure 9) on the FLEXsense™ sensor to the keyed positions on the sensor housing (see Figure 10).
4. Insert the sensor. A click will be felt and heard, ensuring the sensor has been inserted correctly.
5. Twist the sensor locking pin 90 degrees and release to engage the sensor locking pin.
6. Push button to activate sensor.

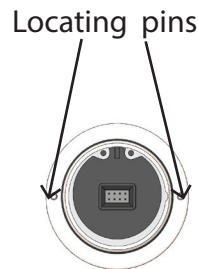

Figure 9

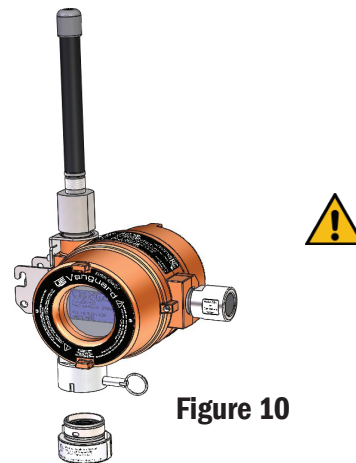

Figure 10

For Combustible Sensor Only

7. Once the button is pushed, the base transmitter initializes the sensor activation process. During this activation, the screen in Figure 11 will be displayed. This activation may take up to 2 minutes.

ACTIVATING
PLEASE
WAIT

Figure 11

8. The device will prompt the user to zero the offset. As shown in Figure 12.

CH4 XX %LEL
PRESS AND HOLD BUTTON
TO ZERO SENSOR
OR PUSH TO SKIP

Figure 12

A. To zero the offset, press and hold the calibration button until seeing the display screen in Figure 13. This takes about 10 seconds.

B. To ignore the offset, press and release the calibration button to skip the zeroing process to step 9.

ZEROING DONE
SENSOR ACTIVE
CALIBRATE NEW SENSOR

Figure 13

For All Sensors

9. Once the sensor initialization process is complete, a "Sensor Active Calibrate New Sensors" message will show (see Figure 14) before automatically returning to home screen (Figure 8).



SENSOR
ACTIVE
CALIBRATE
NEW SENSORS



Figure 14

10. The sensor is self-configuring with the device and once booted up (see Section 2.8 Network Configuration) will display the proper gas concentration.



NOTE: To zero the combustible sensor at any time, press and hold the calibration button for 10 seconds. Refer to section 2.2, step 8, to continue sequence.

2.3 Sensor Placement Considerations

  Exposure to toxic gas may result in loss of consciousness or death. See Annex 1 for toxic gas sensor details.

  Combustible gas accumulation in closed areas may cause explosion, and result in loss of consciousness or death. See Annex 1 for combustible gas sensor details.

 This device must be mounted vertically with the sensor pointing downward.

  This device is suitable for Class I, Divisions 1 & 2, Groups A,B,C,D; or non-hazardous locations only. -40°C (-40°F) $\leq T_{\text{amb.}} \leq 65^{\circ}\text{C}$ (149°F)*. Enclosure Type 4X and IP66**

 This device is ATEX and IECEx certified for equipment category 2. Suitable for appropriate use in gas zone 1.

*Ambient operating temperature range may vary with sensor type. See Technical Brochure for sensor specifications.

**Enclosure Type 4X and IP66 rating excludes sensor.

Individual applications need to be assessed for correct sensor placement. The target gas needs to be determined along with the gas density, and potential coverage area.



For gases that are heavier than air, sensor installation is recommended near the ground and below the potential leak source.



For gases that are lighter than air, sensor installation is recommended near the ceiling (in an enclosed space) and above the potential leak source.

Chemical Abstracts Service (CAS), a division of the American Chemical Society, is the world's authority for chemical information. Please consult the database at www.cas.org for chemical properties of gas.









Other factors to consider include but are not limited to:

- Location – takes into account gas leak source, pressure of release, temperature, and distance to sensor.
- Air flow – prevailing winds, velocity, fans, exhaust ducts that could affect detection.
- Environmental conditions – other than air flow; such as exposure to water, snow, and dirt. Also temperature – hot and cold – and how that may affect the gas release.
- Maintenance Accessibility – provide safe access for calibration and maintenance.

2.4 Sensor Cross Sensitivity

Depending on the type of sensor installed, the device has the ability to detect either Toxic or Combustible gas. The tables and graph located in Annex 1 demonstrate the typical cross sensitivities of each sensor to other gases that may be present while monitoring.



2.5 Classified Area Installation

-   This device is suitable for Class I, Divisions 1 & 2, Groups A,B,C,D; or non-hazardous locations only. -40°C (-40°F) $\leq T_{\text{amb.}} \leq 65^{\circ}\text{C}$ (149°F)*. Enclosure Type 4X and IP66**.
-  This device is ATEX and IECEx certified for equipment category 2. Suitable for appropriate use in gas zone 1.
-  Install device only into areas matching approvals on device labeling.
-  Do not remove the front (painted aluminum and glass) cover in hazardous area.
-  Install the device where shock, vibration and temperature fluctuations are minimal. Do not mount in ambient temperatures that exceed the limits on the device labeling.
-  This device is for monitoring and communicating gas concentration levels for data collection or record keeping and does not provide any alarm signals.
-  To prevent seizure of enclosure cover, do not remove lubricant. Threads should also be free of dirt, etc.

*Ambient operating temperature range may vary with sensor type. See Technical Brochure for sensor specifications.

**Enclosure Type 4X and IP66 rating excludes sensor.

2.6 Field Mounting

-  This device must be mounted vertically with the sensor pointing downward.
-  Install device where shock, vibration and temperature fluctuations are minimal. Do not mount in ambient temperatures that exceed the limits on the device labeling.
-  The mounting bracket attachment on this device is factory-installed and must not be removed as it may cause permanent damage to the antenna, the sensor assembly, and loosening of the threaded flame-proof joints. Removal will void hazardous location approvals, and manufacturer warranty.

This device may be mounted in any of the following configurations using any of the three Vanguard FLEXmount™ options: Standard mount, Magnet mount, or Universal mount.

2.6.1 Standard Mount - Vertical

1. Remove hardware from packaging (see Figure 15).
2. Place one pipe mount adaptor [1] onto desired location horizontally on pipe and slide U-bolt [2] through holes.
3. Slide mounting bracket plate [3] onto U-bolt [2] and secure with (2x) hex nuts [4]. Do not tighten.
4. Repeat step 2 with second pipe mount adaptor [1] also sliding U-bolt [2] through mounting bracket plate [3] and securing with (2x) hex nuts [4].
5. Once position is set, tighten (4x) hex nuts using 1/2" wrench.
6. Mount device by hooking onto top pin of mounting bracket plate (see Figure 16).
7. Push attached pin [5] through bottom holes to secure device to the bracket (see Figure 17).

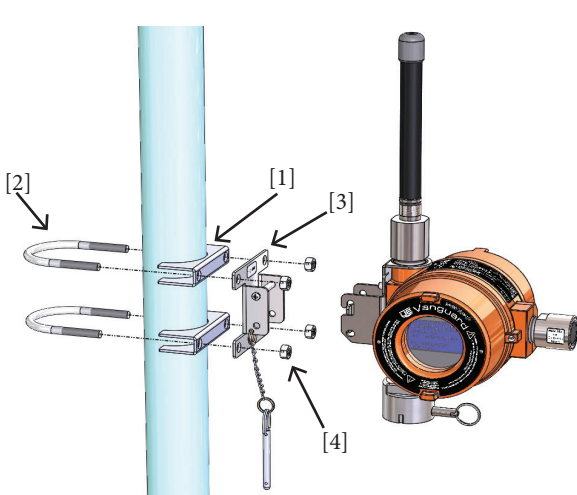

Figure 15

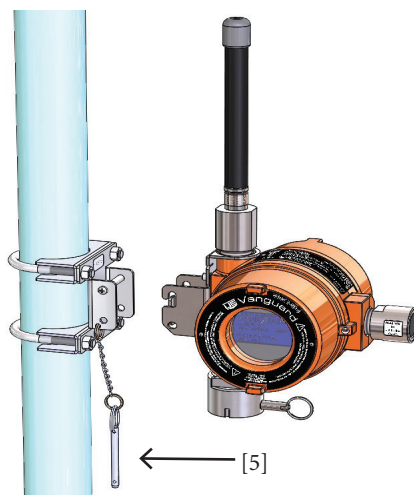

Figure 16

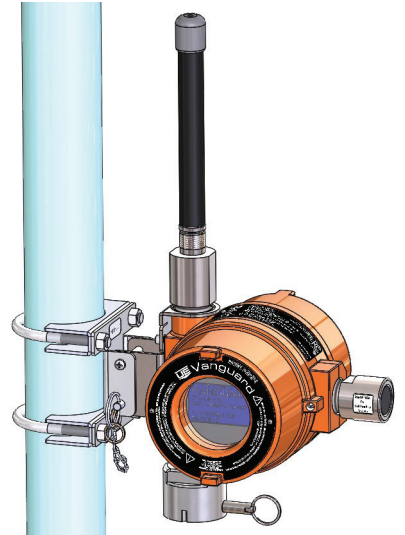

Figure 17

2.6.2 Standard Mount - Horizontal

1. Remove hardware from packaging (see Figure 15).
2. Place one pipe mount adaptor [1] onto desired location vertically on pipe and slide U-bolt [2] through holes.
3. Slide mounting bracket plate [3] onto U-bolt [2] and secure with (2x) hex nuts [4]. Do not tighten.
4. Repeat step 2 with second pipe mount adaptor [1] also sliding U-bolt [2] through mounting bracket plate [3] and securing with (2x) hex nuts [4].
5. Once position is set, tighten (4x) hex nuts using 1/2" wrench.
6. Mount device by hooking onto top pin of mounting bracket plate (see Figure 18).
7. Push attached pin [5] through bottom holes to secure device to the bracket (see Figure 19).

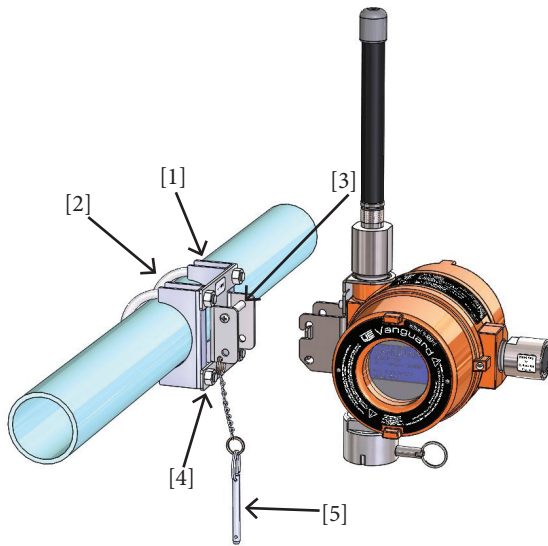

Figure 18

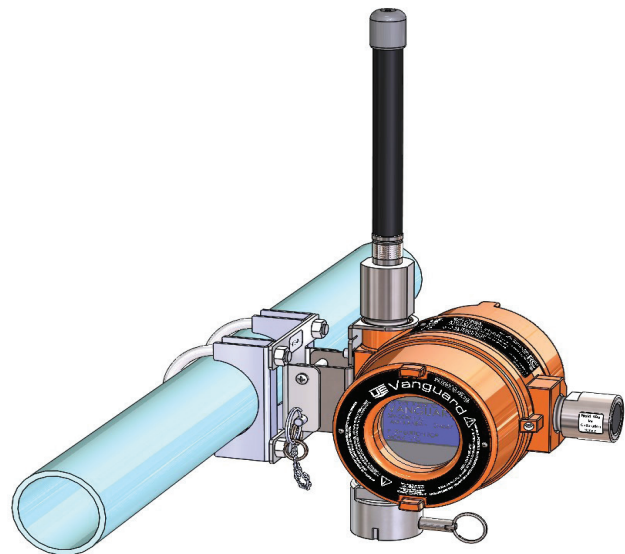
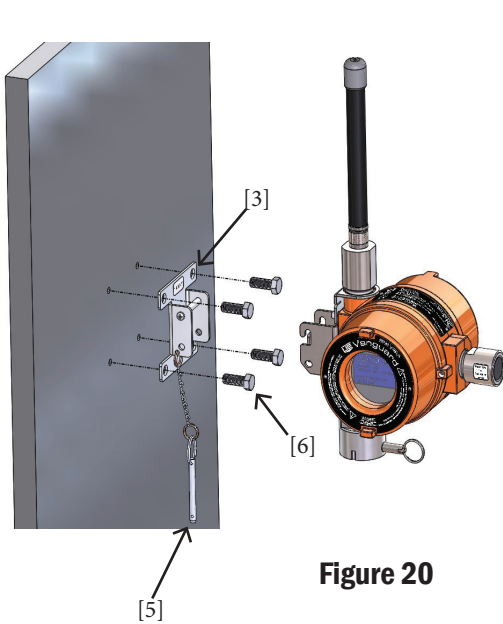

Figure 19



2.6.3 Standard Mount - Wall

 Wall mounting could affect the signal strength of the device

1. Remove hardware from packaging (see Figure 20).
2. Hold mounting bracket plate [3] against wall/flat surface and screw tightly into place using (4x) mounting holes (0.40" dia.).
Note: Mounting screws [6] not UE provided.
3. Mount device by hooking onto top pin of mounting bracket plate (see Figure 21).
4. Push attached pin [5] through bottom holes to secure device to the bracket (see Figure 22).



2.6.4 Magnetic Mount

-  Caution: magnets may cause pinch points.
-  Magnet contact force is dependent on surface condition and flatness. Mount to flat, dry, clean surfaces that are not subject to extreme environmental conditions.
-  This solution should not be used for overhead mounting.

1. Remove hardware from packaging (see Figure 23).
2. Attach device to mounting bracket by hooking onto top pin of mounting bracket plate (see Figure 24).
3. Push attached pin [5] through bottom holes to secure device to the bracket (see Figure 24).
4. Align magnet mount [7] to mounting location.
5. Place onto location gently or using a top-to-bottom “peeling” motion (Figure 25).
6. Use the same top-to-bottom peeling motion to remove the mount from the wall.

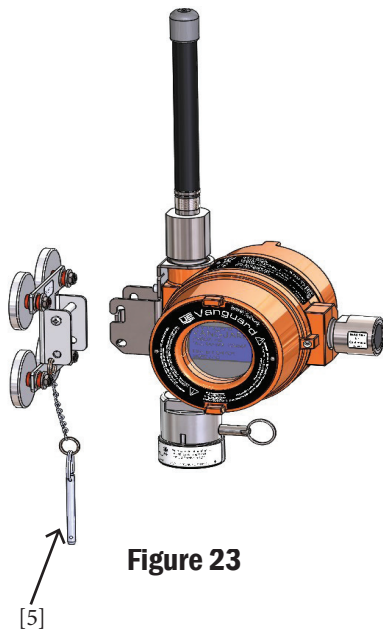

Figure 23

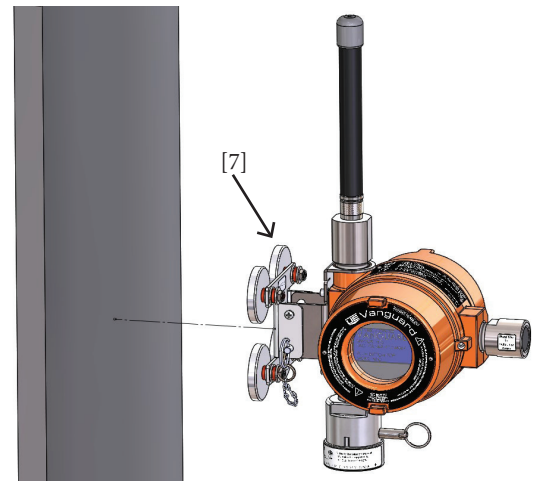

Figure 24



Figure 25

2.6.5 Universal Mount

1. Remove hardware from packaging (see Figure 26).
2. Thread clamp [8] through the holes on the mounting bracket plate [3] (see Figure 26, 27).
3. Wrap the clamp [8] around the mounting structure and insert the end under the worm drive screw [9] (see Figure 28).
4. Pull the end through until it is hand tight around the mounting structure and flip down the worm drive screw [9].
5. Use a socket or screwdriver to tighten the clamp. This clamp should lock into place and be tool-tight.
6. Mount device by hooking onto top pin of mounting bracket plate (see Figure 28).
7. Push attached pin [5] through bottom holes to secure device to the bracket (see Figure 29).

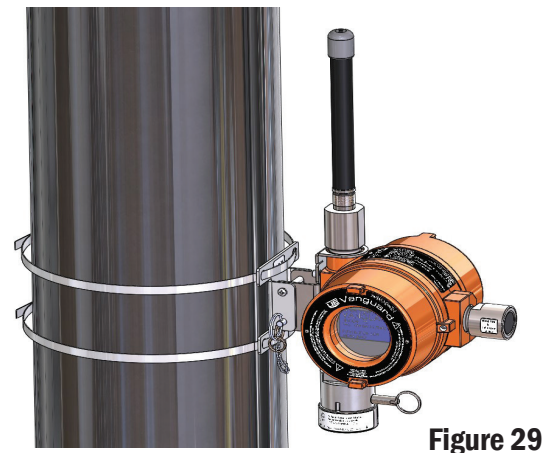
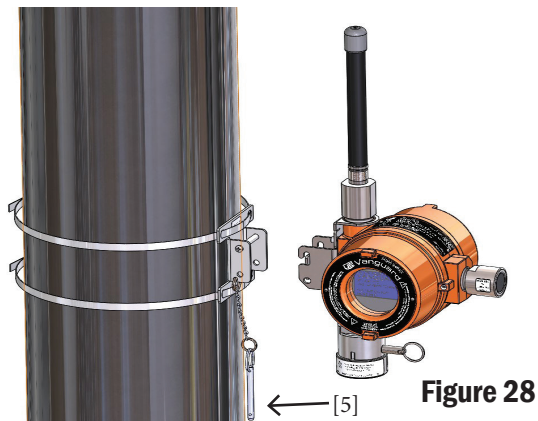
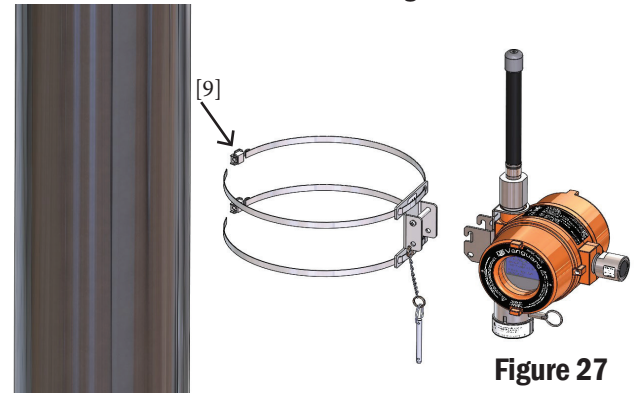
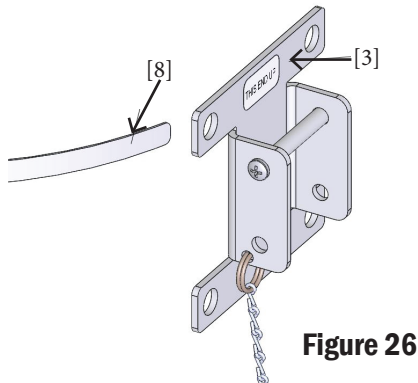



2.6.6 Device removal from mounting bracket plate

Removing the device from the mounting bracket plate for maintenance or calibration is simple.

1. Pull attached pin [5] through bottom holes using the pull ring.

2.7 Antenna Placement Considerations

 This device complies with Part 15 of the FCC rules: may not cause harmful interference; must accept any interference, including that which may cause undesired operation of the device.

 To comply with IC RF exposure compliance requirements, the antenna used for this device must be installed to provide a separation distance of at least 20cm from all persons.

 FCC ID SJC-ETERNA2 contains IC 5853(A)-ETERNA2 CE0976

 Wall mounting could affect the signal strength of the device.

The antenna supplied with the device is an omnidirectional antenna, permanently affixed to the product. In order to facilitate communication with other WirelessHART devices as part of a wireless mesh network, it is recommended that the device be mounted with a minimum of obstructions and noise interference. The maximum range of communication between the device and other devices (instrumentation, repeaters, gateways) is 750 feet (229 meters).

2.8 Network Configuration

 A Network ID and Join Key are required to communicate over the wireless network.

It is recommended that network configuration be performed right after battery installation to maximize battery life. The device must be configured to communicate over the wireless network. A Network ID and Join Key are required, and must match the Network ID and Join Key of the wireless gateway and other wireless devices in the network.

 This device sends critical gas concentration information reliably and securely via WirelessHART communication protocol, version 7.2. Configuration can be completed using the UE Vanguard Configurator Unit, any HART handheld communicator, or directly into the control system using a HART modem. HART terminals are located inside the intrinsically safe battery compartment and are clearly marked (see Figure 24).

 Configuring the gas detection device in the hazardous area requires a suitable, approved intrinsically safe device (such as a handheld communicator, etc.). The entity parameters of the device being connected must be compatible with those of the gas detection device.

Before connecting any device in the hazardous location, the following entity parameters must be verified:

$$\begin{aligned} U_o &\leq U_i \text{ prog} & L_o &\geq L_i \text{ prog} \\ I_o &\leq I_i \text{ prog} & U_i &\geq U_o \text{ prog} \\ P_o &\leq P_i \text{ prog} & I_i &\geq I_o \text{ prog} \\ C_o &\geq C_i \text{ prog} \end{aligned}$$

Gas Detector Intrinsic Safety Entity Parameters:

$U_o = 4.935V$; $I_o = 0.179A$; $P_o = 0.22W$; $C_o = 25\mu F$; $L_o = 0.25mH$

$U_i = 3.8V$; $I_i = 64\mu A$; $C_i = \text{Negligible}$; $L_i = \text{Negligible}$

Connected Device Entity Parameters (will vary dependent upon device):

U_{i_prog} = Max. voltage that can be connected at the input to the handheld or other programming device

I_{i_prog} = Max. current that can be connected at the input to the handheld or other programming device

P_{i_prog} = Max. power that can be connected at the input to the handheld or other programming device

L_{i_prog} = Max. inductance that can be connected at the input to the handheld or other programming device

C_{i_prog} = Max. capacitance that can be connected at the input to the handheld or other programming device

U_{o_prog} = Max. voltage that the handheld or other programming device can source to the device being programmed

I_{o_prog} = Max. current that the handheld or other programming device can source to the device being programmed

2.8.1 Using the UE Vanguard Configurator Unit

Contact UE to inquire about the UE Vanguard Configurator Unit. This unit can be used to commission the Vanguard onto the network and edit the communication settings of the Vanguard.

2.8.2 Download Device Description (DD)

Download the latest DD at www.ueonline.com/vanguard/dd.html to ensure optimum communication between HART devices, gateway and host system.

Refer to www.ueonline.com/vanguard/dd.html for instructions on how to download the DD into the 475 Field Communicator using the Easy Upgrade Utility.

Note: HART Registration of this device is pending. When achieved, the latest DD will be downloadable from www.fieldcommgroup.org.

2.8.3 Using a Handheld HART Communicator

1. If not previously done (from installing the battery – see Section 2.1 Battery Installation), unscrew the solid, back cover from the intrinsically safe battery compartment and set aside.
2. Confirm battery installation or install battery (see Section 2.1 Battery Installation).
3. Push the button on the side of the device to activate the wired HART interface.
4. Connect wires from handheld HART communicator to HART terminals (see Figure 30).
5. The handheld HART communicator will search for a HART-compatible device and indicate if a connection was made.
6. Obtain the Network ID and Join Key of the wireless network to which the device will be joined. This information can be found under the Settings section on the web server supporting the wireless Gateway. Consult the wireless Gateway manual for additional information.

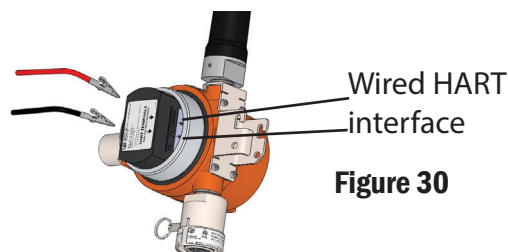

Figure 30

7. Navigating through the handheld HART communicator menu, choose Configure Network ID and enter the Network ID. The operation will use WirelessHART commands 773-Write Network ID and 774-Read Network ID.

Note: Use *Quick Code 9, 2, 1 to be taken directly to the Configure Network ID choice.

*Quick Codes may not work with all handheld HART communicators.

8. Navigating through the handheld HART communicator menu, choose Configure Join Key and enter the Join Key. This operation will use WirelessHART command 768-Write Join Key.

Note: Use *Quick Code 9, 2, 2 through 9, 2, 5 to be taken directly to the Configure Join Key choice.

9. Upon inputting the Network ID and Join Key, the device initializes connection with the network in the following phases. The phase status will be indicated on the device display.

- A. Idle: The device is accepting configuration commands (see Figure 31).

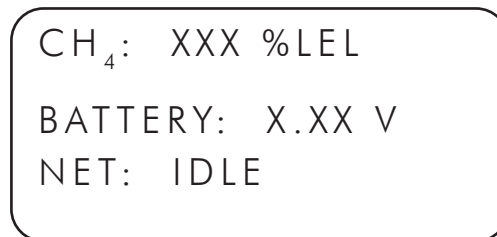

CH₄: XXX %LEL
BATTERY: X.XX V
NET: IDLE

Figure 31

- B. Searching: Once the device receives a join command, it proceeds to the Searching mode. The device keeps its receiver activated while searching for available networks (see Figure 32).

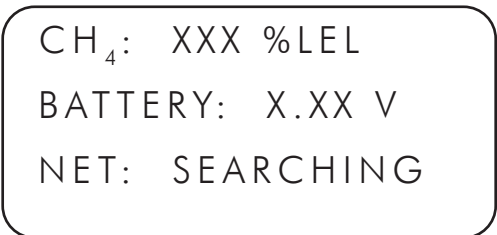

CH₄: XXX %LEL
BATTERY: X.XX V
NET: SEARCHING

Figure 32

- C. Negotiating: The device has detected the desired network and has received a join request from the network manager (see Figure 33).

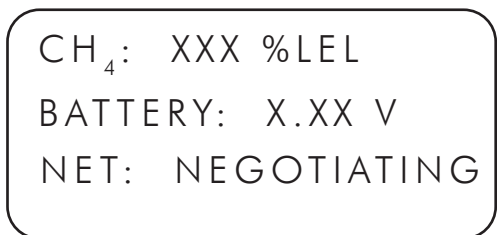

CH₄: XXX %LEL
BATTERY: X.XX V
NET: NEGOTIATING

Figure 33

*Quick Codes may not work with all handheld HART communicators.

- D. Connected: The device should now be joined to the network (see Figure 34). If the device fails to join the wireless mesh network, consult the Troubleshooting Guide (see Section 5.0).

Note: Data transfer is not possible yet.



```

CH4: XXX %LEL
BATTERY: X.XX V
NET: CONNECTED

```

Figure 34

- E. Operational: When the device has sufficient bandwidth with the network manager, data transfer can occur and the device is operational (see Figure 35).

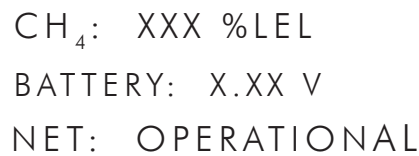

```

CH4: XXX %LEL
BATTERY: X.XX V
NET: OPERATIONAL

```



Figure 35

10. Disconnect wires from the HART terminals and secure cover onto enclosure by tightening until all threads have been fully engaged to ensure proper ingress protection.

2.8.4 HART Modem

1. If not previously done (from installing the battery – see Section 2.1 Battery Installation), unscrew the solid, back cover from the intrinsically safe battery compartment and set aside.
2. Confirm battery installation or install battery (see Section 2.1 Battery Installation).
3. Push the button on the side of the device to activate the wired HART interface.
4. Connect wires from HART Modem to HART terminals (see Figure 24).
Note: The HART modem should be connected to a computer running HART compatible software.
5. Obtain the Network ID and Join Key of the wireless network to which the device will be joined. This information can be found under the Settings section on the web server supporting the wireless Gateway. Consult the wireless Gateway manual for additional information.
6. There are two ways to connect to the wireless mesh network.
 1. Identify the device icon on the Gateway software and drag and drop the icon onto the Gateway icon.
 2. Open the device menu options and enter the Network ID and Join Key manually.
7. Upon inputting the Network ID and Join Key, the device initializes connection with the network in the following phases. The phase status will be indicated on the device display. Refer to Figures 31-35.
8. If the device fails to join the wireless mesh network, consult the Troubleshooting Guide (see Section 5.0).
9. Disconnect wires from the HART terminals and secure cover onto enclosure by tightening until all threads have been fully engaged to ensure proper ingress protection.

3.0 OPERATION

-  This device is for monitoring and communicating gas concentration levels for data collection or record keeping and does not provide alarm signals.
-  Misuse of this product may cause explosion and/or personal injury. These instructions must be thoroughly read and understood prior to installation of the unit.
-  The end-user is responsible for maintaining the device in full, operational condition.

This device is an explosion-proof and intrinsically safe, WirelessHART point gas detector used for the detection of harmful gases in air, in order to help maintain a safe environment. Gas measurement readings are communicated along with network and battery status via a local, digital display, and via WirelessHART 7.2 communication protocol.

3.1 Normal Operation

Under normal operation, the four variables (Table 2) are communicated via WirelessHART 7.2 communication protocol every 8 seconds by default using burst message 0. The update rate is programmable from 8 seconds up to 3600 seconds. Up to three burst messages (0-2) can be configured using the device descriptor. The burst message transmits a chosen HART command to publish data. HART commands that can be burst include: 1, 2, 3, 9, 33, and 48. The default configuration uses command 9.

Device Variable	Process Variable	Units	Accessibility
Primary Variable (PV)	Gas Concentration	ppm, %LEL, %VOL, or ppb	Read
Secondary Variable (SV)*	Temperature	Degrees C	Read
Tertiary Variable (TV)	Days Since Calibration	Days	Read
Quaternary Variable (QV)	Battery Voltage	Volts	Read

Table 1

*Not available on the combustible sensor.

Note: At the device, via the local, digital display, two variables are communicated by pushing the button once – the PV and QV (see Table 2).

The following procedure should be used to configure a burst message:

1. Turn off any burst messages to be changed prior to configuration.
2. Select the burst message and Hart command for publishing. Consider what update rate is to be used based on application. Faster update rates can impact battery life.
Note: A predefined setup can be used to automatically configure commands 9 and 48 for bursting with a default update rate of 8 seconds.
3. Enable burst messages.

The following quick codes can be used to configure burst messages using a handheld device:

1. Burst Setup (9, 5, 1) - Allows configuration of the content of the burst message, and what update rates are to be used.
2. Burst Mode Start/Stop (9, 5, 2) - Turns on/off publishing of a selected burst message.
3. Clear Burst Mode Data (9, 5, 3) - Resets any configuration performed on a burst message.
Note: Publishing must be turned off before a reset can be performed.
4. Burst Mode State (9, 5, 4) - Displays which burst messages are configured.

3.2 Sensor Calibration & Bump Test

 Thoroughly read and understand all Safety Data Sheets (SDS) and warnings associated with gases used for calibration and/or bump testing.

 During sensor calibration mode, the device is not operational or communicating data. Proper care should be taken to ensure that surrounding environment is free of toxic or combustible gases. It is recommended that other gas detection be deployed during sensor calibration and/or bump testing to prevent explosion, serious injury or death.

 Sensors must be activated before use.

Depending upon the use of the device, a calibration check or a bump test may need to be performed. It is recommended to perform the calibration or bump test with the UE Vanguard gas calibration kit (setup instructions included). Either of these tests are done to ensure that the sensor will respond as intended to a predetermined, measured gas release. UE recommends following the end user's standard practices for gas detection sensor calibration and bump testing. See Annex 1 for sensor detection ranges.

3.2.1 Bump Test

1. Select and use a test gas cylinder of a known concentration.
Note: Combustible sensors are maintenance-free and do not require calibration for up to 30 months. However, UE does recommend periodic bump testing to assure optimum performance.
2. If the reading on the display does not match the analytical composition of the test gas cylinder go to section 3.2.2 to calibrate the Vanguard.

3.2.2 Sensor Calibration

1. Select and use a test gas cylinder of a known concentration of the sensor being calibrated. The concentration of the test gas must be between 10% to 100% of the full scale range of the sensor.
Note: See Annex 1 for factory settings of expected test gas concentration. This configuration for test gas concentration can be changed using HART command 129.
2. Press and hold the calibration button for 10 seconds to begin the calibration process.
Note: During this process, the device will be placed in calibration mode. The primary variable (i.e., gas concentration) will still be transmitted to the gateway but fixed at a value of 0. A mode bit indicating that the device is in calibration mode will also be transmitted. This feature is to avoid false alarms during calibration.
Note: If there is no activity detected for 10 minutes during the calibration mode, the device will return to measurement mode.

Offset Zeroing

3. The screen shown in Figure 36 will appear. Ensure that the area is free from hazardous gas or else apply zero air to the sensor. Press and hold the calibration button for 10 seconds. Successful offset zeroing will show the prompt, in Figure 37 below.



CH4 XX %LEL
PRESS AND HOLD BUTTON
TO ZERO SENSOR
OR PUSH TO SKIP

Figure 36



ZEROING DONE

Figure 37

Span Adjustment

4. If either a successful offset calibration was performed or this step was entered with no offset applied, the prompt shown in Figure 38 will be displayed.

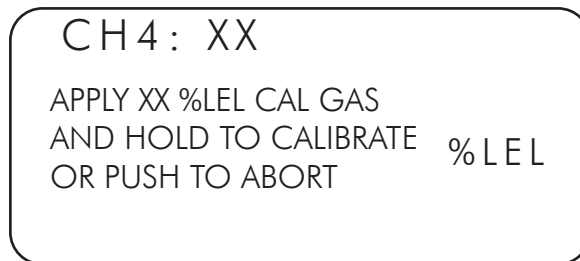

CH4: XX
APPLY XX %LEL CAL GAS
AND HOLD TO CALIBRATE %LEL
OR PUSH TO ABORT

Figure 38

5. Apply the test gas to the sensor with the aid of the UE Vanguard gas calibration kit.
6. Apply the gas for a minimum of 2 minutes or until gas concentration readings on the display are stable. (See Annex 1 for details.)
7. Push and hold the button for approximately 10 seconds. Successful calibration will display 'Calibration Done' on the local, digital display (see Figure 39).



CALIBRATION
DONE
SET TO : XX %LEL

Figure 39

Note: Unsuccessful calibration will display 'Calibration Failed' on the local, digital display. This indicates that the sensor reading is out of specification and a new sensor is required (see Section 4.1 Sensor Replacement).

8. Remove calibration cup and allow gas to clear, as shown in Figure 40.

Note: Device will return to measurement mode when concentration is less than 2% of full scale range.

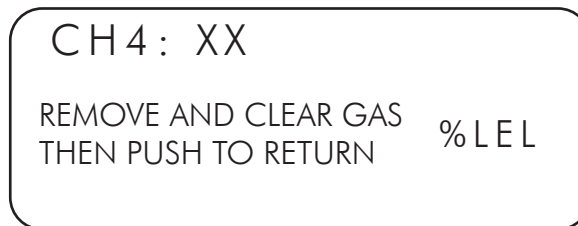

Figure 40

3.3 Programming Mode

This section describes the HART Commands used in the device.

3.3.1 Universal Commands

The Universal Commands are the minimum command set for all HART devices and provide access to information useful in normal device operation. Table 2 shows the supported Universal Commands for this device.

0	Read Unique Identifier	14	Read Primary Variable Transducer Information
1	Read Primary Variable	15	Read Device Information
2	Read Loop Current and Percent Range	16	Read Final Assembly Number
3	Read Dynamic Variables and Loop Current	17	Write Tag, Descriptor, Date
6	Write Polling Address	18	Write Tag, Descriptor, Date
7	Read Loop Configuration	19	Write Final Assembly Number
8	Read Dynamic Variable Classifications	20	Read Long Tag
9	Read Device Variables with Status	21	Read Unique Identifier Associated with Long Tag
11	Read Unique Identifier Associated with Tag	22	Write Long Tag
12	Read Message	38	Reset Configuration Changed Flag
13	Read Tag, Descriptor, Date	48	Read Additional Device Status

Table 2

3.3.2 Common Practice Commands

The Common Practice Commands are an optional command set for HART devices. Table 3 shows the supported Common Practice Commands for this device.

33	Read Device Variables	90	Read Real-Time Clock
34	Read Primary Variable Damping Value	103	Write Burst Period
35	Write Primary Variable Range Values	104	Write Burst Trigger
42	Perform Device Reset	105	Read Burst Mode Configuration
44	Write Primary Variable Units	106	Flush Delayed Response Buffers
47	Write Primary Variable Transfer Function	107	Write Burst Device Variables
50	Read Dynamic Variable Assignment	108	Write Burst Mode Command Number
51	Write Dynamic Variable Assignments	109	Burst Mode Control
54	Read Device Variable Assignments	115	Read Event Notification Bit Mask
59	Write Number of Response Preambles	116	Write Event Notification Bit Mark
78	Read Aggregated Commands	117	Write Event Notification Timing
79	Write Device Variables	118	Event Notification Control
		119	Acknowledge Event Notification

Table 3

3.3.3 Device Specific Commands

The Device Specific Commands are commands unique to this device only. These commands are included in the Device Description (DD). Download the latest DD* at www.ueonline.com to ensure optimum communication between HART devices, gateway and host system. Table 4 shows the supported Device Specific Commands for this device.

*The downloaded files should be placed in a folder named with the manufacturer ID number and then a child folder created using the device type number. The folder should then be copied to the directory where DD files are stored. New DD files simply replace the old and work with all revisions of the same device.

128	Read Calibration Point
129	Write Calibration Point
131	Read Sensor Activation State
132	Read Base Unit Configuration String
133	Read Sensor Module Configuration String
138	Read Sensor Type String

Table 4

3.3.4 HART Command 128 Read Calibration Point

Request bytes:

Bytes	Format	Description
None		

Response byte:

Bytes	Format	Description
0-3	Float	Concentration of gas used during calibration

Command Specific Response Code:

Code	Class	Description
0	Success	No command specific errors

Table 5

3.3.5 HART Command 129 Write Calibration Point

Request bytes:

Bytes	Format	Description
0-3	Float	Concentration of gas used during calibration

Response bytes:

Bytes	Format	Description
0-3	Float	Concentration of gas used during calibration

Command Specific Response Code:

Code	Class	Description
0	Success	No command specific errors
2	Error	Concentration too low
3	Error	Concentration too high
4	Error	Concentration not valid
5	Error	Incorrect number of data bytes received

Table 6

3.3.6 HART Command 131 Read Sensor Activation State

Request bytes:

Bytes	Format	Description
None		

Response bytes:

Bytes	Format	Description
0-1	Unsigned-16	Sensor type (0=Not Activated)

Command Specific Response Code:

Code	Class	Description
0	Success	No command specific errors

Table 7

3.3.7 HART Command 132 Read Base Unit Configuration String

Request bytes:

Bytes	Format	Description
None		

Response byte:

Bytes	Format	Description
0-39	Latin-1	Unit Configuration String, (e.g., UEC100 SW 2.20 HW 1.21)

Command Specific Response Code:

Code	Class	Description
0	Success	No command specific errors

Table 8

3.3.8 HART Command 133 Read Sensor Module Configuration String

Request bytes:

Bytes	Format	Description
None		

Response byte:

Bytes	Format	Description
0-39	Latin-1	Sensor Module Configuration String (e.g., H ₂ S: 02031 08035278 02 MIPEX-2_25.6)

Command Specific Response Code:

Code	Class	Description
0	Success	No command specific errors

Table 9

3.3.9 HART Command 138 Read Sensor Type String

Request bytes:

Bytes	Format	Description
0	Unsigned 8	Device Variable Code

Response bytes:

Bytes	Format	Description
0	Unsigned 8	Device Variable Code
1-16	ISO-Latin1	Variable Type String





Command-Specific Response Codes

Code	Class	Description
0	Success	No command specific errors
1	Error	Wrong Number of Data Bytes
2	Error	Invalid Selection

Table 10

4.0 FIELD REPLACEMENT

4.1 Sensor Replacement

-  The sensor is certified intrinsically safe. Sensor replacement may be performed in the field without a hot work permit.
-  Only FLEXsense™ sensors provided by United Electric Controls are compatible with this device.
-  Do not attempt to disassemble the sensor as this could damage the sensor and void hazardous location approvals, and manufacturer warranty.
-  Sensors must be activated after installation.
-  When replacing the sensor, proper care should be taken to ensure that surrounding environment is free of toxic or combustible gases. It is recommended that other gas detection be deployed during sensor replacement to prevent explosion, serious injury or death.

Locate the FLEXsense™ sensor housing (see Figure 41) and retract the sensor locking pin, twisting 90 degrees to lock into retracted position. Remove the gas sensor assembly by firmly pulling downward and releasing it from the sensor unit (see Figure 42). Remove the new FLEXsense™ sensor from its package and follow the instructions from Section 2.2 Sensor Installation.

Note: It is not necessary to remove the battery during sensor replacement.

-  UE recommends performing the sensor calibration procedure as outlined in Section 3.2 Sensor Calibration & Bump Test.

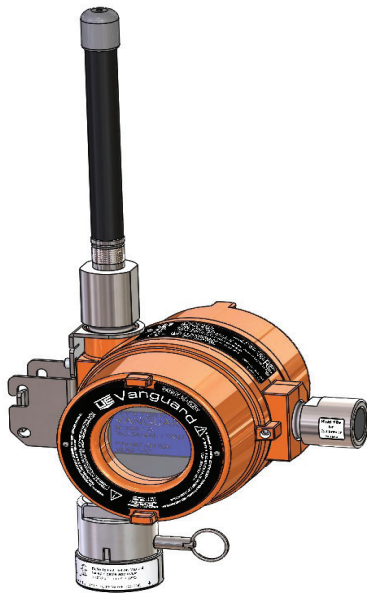

Figure 41

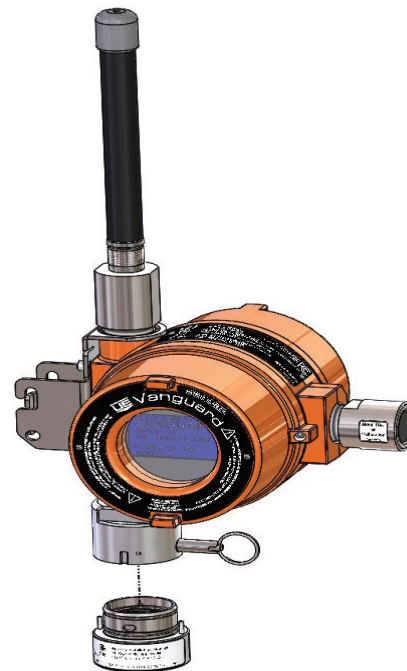







Figure 42

4.2 BATTERY REPLACEMENT

-  The battery compartment is certified intrinsically safe. Battery replacement may be performed in the field without a hot work permit.
-  Only battery packs provided by United Electric Controls are compatible with this device.
-  When replacing the battery, proper care should be taken to ensure that surrounding environment is free of toxic or combustible gases. It is recommended that other gas detection be deployed during battery replacement to prevent explosion, serious injury or death.
-  Batteries are not rechargeable.
-  Follow proper disposal regulations for lithium batteries as applies to the local jurisdiction.
-  The sensor must be calibrated after battery replacement (see Section 3.2.1).

Locate the battery compartment and remove the battery compartment cover to expose the battery. Remove the battery by gripping the back of the battery pack and firmly pulling back from the enclosure, releasing it from the battery socket. Slide the battery pack out of the compartment (see Figure 43).

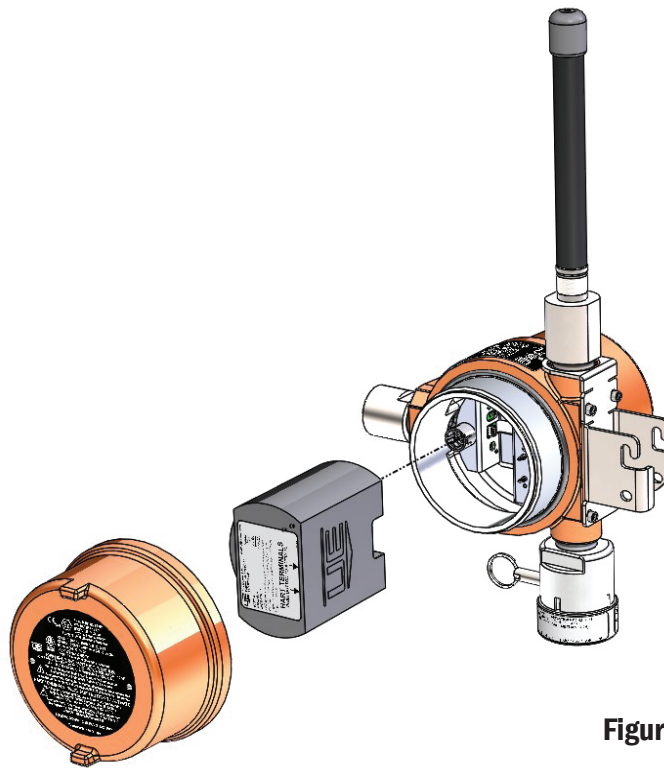

Figure 43

Remove the new battery from its packaging and follow steps 3-6, 9 from Section 2.1 Battery Installation.

5.0 TROUBLESHOOTING GUIDE

The Vanguard WirelessHART gas detector is used as part of a wireless mesh network that may communicate with other manufacturers' WirelessHART devices, Gateways, and control systems. The following provides troubleshooting suggestions for common operating problems that may be encountered.

5.1 Hardware

SYMPTOM	POSSIBLE CAUSES	RECOMMENDED ACTIONS
Sensor is not recognized by the device	Poor connection between sensor and device	Check the integrity of the 8-pin connector in the sensor. Pins must not be bent.
	Incorrect placement of sensor	Ensure that the sensor is completely snapped in place.
Device does not operate (i.e., device does not refresh even if button was pushed)	Battery not connected properly	Check the battery is seated properly in the battery compartment.
		Check the integrity of the 5-pin connector at the battery port. Pins must not be bent.
	Battery is dead	Check battery status on the display for available battery life. Replace battery.
Device unable to move beyond the idle or search mode	Incorrect Network ID and Join Key	Check the Network ID and Join Key and attempt rejoining network.
	Network is not self advertising	Check that the network is in the active network advertise mode. Power cycle device and try again.
Device is not responding to the calibration gas	Incorrect gas or gas concentration	Check gas type and concentration.
	Incorrect calibration	Review the Calibration procedure listed within on page 20.
	Poor gas delivery	Check gas delivery equipment components.
	Poor connection between sensor and device	Check the integrity of the 8-pin connector in the sensor.
		Ensure that the sensor is completely snapped into place. Replace the sensor.
LCD does not refresh	Extreme ambient temperature	Transfer device within temperature range -40°C (-40°F) to 65°C (149°F).
	Battery is dead	Check battery status on the display for available battery life. Replace battery if necessary.
	Battery not connected properly	Check the battery is seated properly in the battery compartment.
Check the integrity of the 5-pin connector at the battery port.		
LCD has slow refresh rate	Extreme ambient temperature	A slow refresh rate is normal at low temperature. This is intentional to enhance the viewing of the LCD.

Table 11

5.2 Wireless Communication

Upon inputting the Network ID and Join Key, the device initializes connection with the network in the following phases. The phase status will be indicated on the device display.

1. Idle: The device is accepting configuration commands. Once it receives a join command, it proceeds to the Searching mode.
2. Searching: The device keeps its receiver activated while searching for available networks.
3. Negotiating: The device has detected the desired network and has received a join request from the network manager.
4. Connected: The device has established connection with the network manager and has successfully joined the network. Data transfer is not possible yet.
5. Operational: The device has sufficient bandwidth for communication with the network manager. Data transfer can now occur.

Note: If a handheld communicator is unavailable, use the following WirelessHART Commands to initialize the join process:

- 768 - Write Join Key
- 773 - Write Network ID
- 774 - Read Network ID

Possible issues during the connection process are highlighted in Table 13 below.

Table 12

SYMPTOM	POSSIBLE CAUSES	RECOMMENDED ACTIONS
Device is not joining the network	Battery is not connected properly	Check that the battery is connected correctly. See Section 2.1 on battery installation.
	Incorrect Network ID and Join Key	Check the Network ID and Join Key
	Network is not self advertising	Check that the network is in the active network advertise mode
	Insufficient routing nodes	Check that the device is within the range of at least one other device in the mesh network. Add more wireless points
	Network is oversubscribed with devices	
		Wait for at least 15 minutes after the start up
		Power cycle device and try again
Excessive network rejoins	Antenna issue	Send the device back to factory
		Check antenna signal strength on asset management system
	Unreliable routing nodes	Relocate device so it has multiple communication paths or add another node in between

6.0 DIMENSIONAL DRAWINGS

(CAD drawings may be found at www.ueonline.com)

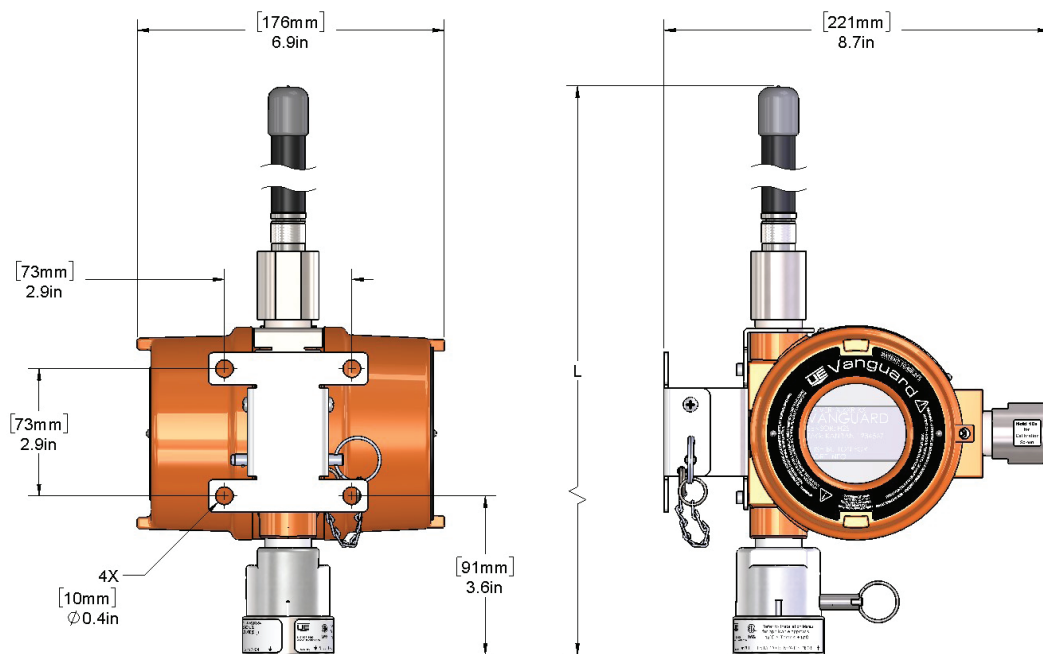

TCD60 Shown with Standard Mount

Model	Option	Gain (dBi)	L
TCD50	1	2	12.4" (315mm)
TCD60	2	2	16.2" (412mm)
	3	4.35	16.6" (422mm)
	4	6	18.9" (482mm)

7.0 APPENDIX

7.1 List of Figures

Page	Figure	Description
2	1	Front view of Vanguard and feature call out
2	2	Rear view of Vanguard and feature call out
3	3	Vanguard packaging, top foam layer
3	4	Vanguard packaging, bottom foam layer
6	5	Battery installation
6	6	Vanguard display showing 'STARTING' screen
7	7	Vanguard display showing 'SENSOR NOT ACTIVATED' screen
7	8	Vanguard display showing 'home' screen with CH ₄ sensor
8	9	FLEXsense™ top view with locating pins
8	10	FLEXsense™ installation
8	11	Vanguard display during the Combustible Sensor activation process
9	12	Vanguard display prompt to zero the offset for Methane Sensor
9	13	Vanguard display after Combustible Sensor zeroing process completed
9	14	Vanguard display showing 'SENSOR ACTIVE' after sensor activation
12	15	Pipe mounting bracket hardware
12	16	Vertical mounting Vanguard to bracket plate
12	17	Securing Vanguard to bracket
13	18	Horizontal mounting Vanguard to bracket plate
13	19	Securing Vanguard to bracket
14	20	Wall mounting bracket hardware
14	21	Wall mounting Vanguard to bracket plate
14	22	Securing Vanguard to bracket
15	23	Magnetic mounting bracket
15	24	Securing Vanguard to bracket
15	25	Magnetic mounting bracket and Vanguard to wall
15	26	Universal mounting bracket hardware assembly
15	27	Universal mounting bracket hardware assembly
15	28	Universal mounting Vanguard to bracket
15	29	Securing Vanguard to bracket
17	30	Rear view of battery compartment and HART terminal location
18	31	Idle command state with CH ₄ sensor
18	32	Searching command state with CH ₄ sensor
18	33	Negotiating command state with CH ₄ sensor
18	34	Connected command state with CH ₄ sensor
19	35	Operational command state with CH ₄ sensor
22	36	Vanguard display prompt to zero the offset for Methane Sensor
22	37	Successful offset zeroing
22	38	Gas calibration prompt

7.1 List of Figures

22	39	Vanguard display showing 'Calibration Done' screen with CH ₄ sensor
23	40	If gas is still present, this prompt is shown
29	41	Front view of Vanguard
29	42	FLEXsense™ replacement
30	43	Battery replacement

7.2 List of Tables

Page	Table	Description
21	1	Measured variables
25	2	Supported Universal HART Commands
25	3	Supported Common Practice HART Commands
26	4	Device Specific HART Commands
26	5	Command 128 Read Calibration Point
27	6	Command 129 Write Calibration Point
28	7	Command 131 Read Sensor Activation State
29	8	Command 132 Read Base Unit Configuration String
29	9	Command 133 Read Sensor Module Configuration String
29	10	Command 138 Read Sensor Type String
32	11	Hardware Symptoms, Causes and Recommended Actions
33	12	Wireless Communication Symptoms, Causes and Recommended Actions
IM_TCD50_ANNEX		Typical cross sensitivity for various gases

7.3 List of Graphs

Page	Graph	Description
IM_TCD50_ANNEX		Typical Cross Sensitivity for various gases.

7.3 List of Device Warnings (French Language)

Page(s)	Warning Text	Texte d'avertissement
1,11,20	This device is for monitoring and communicating gas concentration levels for data collection or record keeping and does not provide alarm signals.	Cet appareil est destiné à la surveillance et à la communication des niveaux de concentration de gaz pour la collecte de données ou la tenue de registres. Il n'émet pas de signal d'alarme.
1,20	Misuse of this device may cause explosion and/or personal injury. These instructions must be thoroughly read and understood prior to installation of the device.	Une mauvaise utilisation de cet appareil peut provoquer une explosion et/ou des blessures. Ces consignes doivent être lues attentivement et bien comprises avant l'installation de l'appareil.
1,20	The end-user is responsible for maintaining the device in full, operational condition.	L'utilisateur final est responsable de l'entretien de l'appareil afin d'assurer un bon état de fonctionnement à pleine capacité.
1	To ensure proper ingress protection, the front and rear covers must be installed, and fully bottomed out against the base enclosure (i.e. metal-to-metal contact). It is recommended to use a wrench or any tool across the cover lugs to tighten the covers down.	Pour assurer une protection adéquate, l'avant et l'arrière couvercles doivent être installés et complètement fondés contre l'enceinte de base (c'est-à-dire contact métal-métal). il est conseillé de une clé ou un outil à travers les onglets de protection pour resserrer les couvercles.
1,9	Exposure to toxic gas may result in loss of consciousness or death. See Annex 1 for toxic gas sensor details.	Une exposition à ce gaz peut provoquer une perte de conscience, voire la mort. Voir l'annexe 1 pour les détails du capteur de gaz toxiques.
1,9	Combustible gas accumulation in closed areas may cause explosion, and result in loss of consciousness or death. See Annex 1 for combustible gas sensor details.	L'accumulation de gaz combustible dans les zones fermées peut provoquer une explosion, et entraîner une perte de conscience ou la mort. Voir l'annexe 1 pour les détails du capteur de gaz combustible.
1	Avoid dropping the device as loosening of the threaded flame-proof joints or permanent damage may occur.	Éviter de faire tomber l'appareil. Ceci pourrait desserrer les joints filetés ignifuges ou endommager l'appareil de façon permanente.
1	New sensors must be calibrated after installation (see Section 3.2).	Les nouveaux capteurs doivent être étalonnés après l'installation (voir Section 3.2).
1	When not in use, the device should be stored in a clean, dry area and within the temperature range listed within the device's environmental specifications.	Lorsqu'il n'est pas utilisé, l'appareil doit être stocké dans un endroit propre et sec et à une plage de températures donnée dans les spécifications environnementales de l'appareil.
3	Device is shipped without the sensor or battery installed. Both must be installed prior to use. See Section 2.0 Installation for further information.	L'appareil est livré sans que le capteur ni la batterie ne soient installés. Les deux doivent être installés avant utilisation. Voir la Section 2.0 « Installation » pour de plus amples informations.
4,9,11	This device is suitable for Class I, Divisions 1 & 2, Groups C and D; or non-hazardous locations only. -40 °C (-40°F) ≤ Tamb. ≤ 65°C (149°F). Enclosure Type 4X and IP66 excludes sensors.	Cet appareil est uniquement adapté à une utilisation dans les lieux de Classe I, Divisions 1 et 2, de Groupes C et D ou non-dangereux. - 40 °C (-40°F) ≤ T amb. ≤ 65°C (149°F). Boîtier de type 4X et IP66 le capteur est exclut.
4,9,11	This device is ATEX and IECEx certified for equipment category 2. Suitable for appropriate use in gas zone 1.	Cet appareil est certifié ATEX et IECEx pour les équipements de catégorie 2. Convient à une utilisation appropriée dans une zone classée 1 (gaz).

7.3 List of Device Warnings (French Language)

Page(s)	Warning Text	Texte d'avertissement
4	The only field replaceable parts are the battery pack and FLEXsense™ sensor. Any substitution of components other than the battery pack and FLEXsense™ sensor will invalidate third-party issued approvals and certifications, and may impair suitability for Class I, Division 1 location.	Le pack batterie et le capteur FLEXsense™ sont les seules parties pouvant être remplacées sur le terrain. Le remplacement de tout composant autre que le capteur FLEXsense™ et le pack batterie invalidera toutes les approbations et certifications données par un tiers. L'appareil peut alors ne plus être adapté à une utilisation dans un lieu de Classe I, Division 1.
6,29	Only battery packs provided by United Electric Controls are compatible with this device.	Seuls les packs de batteries fournis par United Electric Controls sont compatibles avec cet appareil.
6	Battery should be removed and stored when the device is not in use.	Il est préférable de retirer la batterie et de la stocker séparément de l'appareil si celui-ci n'est pas utilisé.
6,29	Batteries are not rechargeable.	Les batteries ne sont pas rechargeables.
8,28	Only FLEXsense™ sensors provided by United Electric Controls are compatible with this device.	Seuls les capteurs FLEXsense™ fournis par United Electric Controls sont compatibles avec cet appareil.
8,28	Do not attempt to disassemble the sensor as this could damage the sensor and void hazardous location approvals, and manufacturer warranty.	Ne pas tenter de démonter le capteur. Ceci pourrait l'endommager et annuler les autorisations d'utilisation dans des endroits dangereux ainsi que la garantie de fabricant.
8,28	Sensors must be activated after installation.	Les capteurs doivent être activés après installation.
9,12	This device must be mounted vertically with the sensor pointing downward.	Cet appareil doit toujours être installé à la verticale avec le capteur dirigé vers le bas.
9	For gases that are heavier than air, sensor installation is recommended near the ground and below the potential leak source.	Pour les gaz plus lourds que l'air, il est recommandé d'installer le capteur près du sol et au-dessous de la source de fuite potentielle.
9	For gases that are lighter than air, sensor installation is recommended near the ceiling (in an enclosed space) and above the potential leak source.	Pour les gaz plus légers que l'air, il est recommandé d'installer le capteur près du plafond (dans un espace clos) et au-dessus de la source de fuite potentielle.
11	Install device only into areas matching approvals on device labeling.	Installer l'appareil uniquement dans des zones correspondant aux recommandations inscrites sur l'étiquette de l'appareil.
11	Do not remove the front (painted aluminum and glass) cover in hazardous area.	Ne pas retirer la face avant de l'appareil (en verre et aluminium peint) en zone dangereuse.
11	Install the device where shock, vibration and temperature fluctuations are minimal. Do not mount in ambient temperatures that exceed the limits on the device labeling.	Installer l'appareil dans un endroit où les chocs, les vibrations et les variations de température sont minimales. Ne pas installer l'appareil dans un lieu où les températures ambiantes dépassent les limites indiquées sur l'étiquette de l'appareil.
11	To prevent seizure of enclosure cover, do not remove lubricant. Threads should also be free of dirt, etc.	Pour éviter que le couvercle ne se gripe, ne pas retirer le lubrifiant. Les filetages doivent également être propres, etc.
12	The mounting bracket attachment on this device is factory-installed and must not be removed as it may cause permanent damage to the antenna, the sensor assembly, and loosening of the threaded flame-proof joints. Removal will void hazardous location approvals, and manufacturer warranty.	La fixation du support de montage de cet appareil est installée en usine et ne doit pas être retirée. Cela pourrait endommager l'antenne et le bloc du capteur et desserrer les joints ignifuges filetés. Leur retrait annule toute garantie d'utilisation dans des zones dangereuses ainsi que la garantie du fabricant.



7.3 List of Device Warnings (French Language)

Page(s)	Warning Text	Texte d'avertissement
14	Wall mounting could affect the signal strength of the device.	Un montage mural pourrait affecter la puissance du signal de l'appareil.
15	Caution magnets may cause pinch points.	Attention, les aimants peuvent causer des points de pincement.
15	Magnet contact for is dependent on surface condition and flatness. Mount to flat, dry, clean surfaces that are not subject to extreme environmental conditions.	Le contact magnétique dépend de l'état de la surface et de la planéité. Monter sur des surfaces plates, sèches et propres non soumises à des conditions environnementales extrêmes.
15	This solution should not be used for overhead mounting.	Cette solution ne doit pas être utilisée pour un montage en hauteur.
16	This device complies with Part 15 of the FCC rules: may not cause harmful interference; must accept any interference, including that which may cause undesired operation of the device.	Cet appareil est conforme à la Section 15 du règlement FCC : ne doit pas provoquer d'interférences nuisibles ; doit accepter n'importe quelle interférence, y compris celles qui pourraient provoquer un dysfonctionnement de l'appareil.
16	To comply with IC RF exposure compliance requirements, the antenna used for this device must be installed to provide a separation distance of at least 20cm from all persons.	Afin de se conformer aux normes d'exposition RF d'Industrie Canada, l'antenne utilisée pour cet appareil doit être installée de façon à avoir une distance de séparation d'au moins 20 cm de toutes les personnes à proximité.
16	FCC ID SJC-ETERNA2 contains IC 5853(A)-ETERNA2 CE0976	FCC ID SJC-ETERNA2 contient IC 5853(A)-ETERNA2 CE0976
16	A Network ID and Join Key are required to communicate over the wireless network.	Un numéro d'identification de réseau et une clé de jonction sont nécessaires pour communiquer par le réseau sans fil.
16	Configuring the gas detection device in the hazardous area requires a suitable, approved intrinsically safe device (such as a handheld communicator, etc.). The entity parameters of the device being connected must be compatible with those of the gas detection device.	La configuration du système de détection de gaz dans la zone dangereuse nécessite un appareil à sécurité intrinsèque adapté et approuvé (tel qu'un communicateur portatif, etc.). Les paramètres d'entité de l'appareil à connecter doivent être compatibles avec ceux du système de détection de gaz.
16	Before connecting any device in the hazardous location, the following entity parameters must be verified:	Avant de connecter un appareil dans un lieu dangereux, il est important de vérifier les paramètres d'entité suivants :
21	Thoroughly read and understand all Safety Data Sheets (SDS) and warnings associated with gases used for calibration and/or bump testing.	Lire attentivement et bien comprendre toutes les fiches de données de sécurité (FDS) et les avertissements associés aux gaz utilisés pour l'étalonnage et/ou les tests de fiabilité.
21	During sensor calibration mode, the device is not operational or communicating data. Proper care should be taken to ensure that surrounding environment is free of toxic or combustible gases. It is recommended that other gas detection be deployed during sensor calibration and/or bump testing to prevent explosion, serious injury or death.	Pendant le mode d'étalonnage du capteur, l'appareil n'est pas opérationnel et ne fournit aucune donnée. Il est important de s'assurer que l'environnement ne contient aucun gaz toxique ou combustible. Il est recommandé d'utiliser un autre système de détection de gaz pendant l'étalonnage et/ou les tests de fiabilité du capteur pour éviter tout risque d'explosion, de blessures graves ou de mort.
21	Sensors must be activated before use.	Les capteurs doivent être activés avant utilisation.



7.3 List of Device Warnings (French Language)

Page(s)	Warning Text	Texte d'avertissement
29	The sensor is certified intrinsically safe. Sensor replacement may be performed in the field without a hot work permit.	Le capteur est certifié à sécurité intrinsèque. Le remplacement du capteur peut être effectué sur le terrain sans permis de travail à chaud.
29	When replacing the sensor, proper care should be taken to ensure the surrounding environment is free of toxic or combustible gases. It is recommended that other gas detection be deployed during sensor replacement to prevent explosion, serious injury or death.	Il est important de s'assurer que l'environnement ne contient aucun gaz toxique ou combustible lors du remplacement du capteur. Il est recommandé d'utiliser un autre système de détection de gaz pendant le remplacement du capteur pour éviter tout risque d'explosion, de blessures graves ou de mort.
29	UE recommends performing the sensor calibration procedure as outlined in Section 3.0 Operation.	UE recommande d'effectuer la procédure d'étalonnage du capteur comme indiqué à la Section 3.0 « Fonctionnement ».
30	The battery compartment is certified intrinsically safe. Battery replacement may be performed in the field without a hot work permit.	Le compartiment pour la batterie est certifié à sécurité intrinsèque. Le remplacement de la batterie peut être effectué sur le terrain sans permis de travail à chaud.
30	When replacing the battery, proper care should be taken to ensure the surrounding environment is free of toxic or combustible gases. It is recommended that other gas detection be deployed during battery replacement to prevent explosion, serious injury or death.	Il est important de s'assurer que l'environnement ne contient aucun gaz toxique ou combustible lors du remplacement de la batterie. Il est recommandé d'utiliser un autre système de détection de gaz pendant le remplacement de la batterie pour éviter tout risque d'explosion, de blessures graves ou de mort.
30	Follow proper disposal regulations for lithium batteries as applies to the local jurisdiction.	Suivre les règles d'élimination appropriées pour les piles au lithium à la juridiction locale.
30	The sensor must be calibrated after battery replacement (see Section 3.2.1).	Le capteur doit être étalonné après le remplacement de la batterie (voir la Section 3.2.1).

Front Cover Nameplate

-  1. WARNING: DO NOT OPEN WHEN EXPLOSIVE ATMOSPHERE IS PRESENT. KEEP COVER TIGHT WHILE IN OPERATION
- 1. AVERTISSEMENT : NE PAS OUVRIR EN PRÉSENCE D'UNE ATMOSPHÈRE EXPLOSIVE. GARDER LE COUVERCLE FERMÉ PENDANT LE FONCTIONNEMENT
-  2. WARNING – POTENTIAL ELECTROSTATIC CHARGING HAZARD – SEE INSTRUCTIONS
- 2. AVERTISSEMENT - DANGER POTENTIEL DE CHARGE ÉLECTROSTATIQUE - VOIR INSTRUCTIONS

Back Cover Nameplate

-  3. WARNING: Reference Installation Manual for Guidance on Compatibility of Intrinsically Safe HART Devices.
- 3. Avertissement: Consulter le manuel d'installation pour obtenir des conseils sur la compatibilité des dispositifs HART à sécurité intrinsèque.
-  4. WARNING: To prevent ignition, use only sensors and batteries supplied by United Electric Controls. UEs UE Battery (Vmax = 7.8V, Imax = 0.17A) Assy # 6361-807.
- 4. Avertissement: Pour éviter toute inflammation, n'utilisez que des capteurs et des batteries fournis par United Electric Controls. Batterie UEs UE (Vmax = 7,8V, Imax = 0,17A) Assy # 6361-807.

RECOMMENDED PRACTICES AND WARNINGS

United Electric Controls Company recommends careful consideration of the following factors when specifying and installing UE gas detectors. Before installing a unit, the Installation and Maintenance instructions provided with unit must be read and understood.

- Install unit where shock, vibration and ambient temperature fluctuations will not damage unit or affect operation. When applicable, orient unit so that moisture does not enter the enclosure via the electrical connection. When appropriate, this entry point should be sealed to prevent moisture entry.
- Unit must not be altered or modified after shipment. Consult UE if modification is necessary.
- Preventative maintenance and periodic testing is necessary for critical applications where damage could endanger property or personnel.
- Do not mount unit in ambient temp. exceeding published limits.

LIMITED WARRANTY

Seller warrants that the product hereby purchased is, upon delivery, free from defects in material and workmanship and that any such product which is found to be defective in such workmanship or material will be repaired or replaced by Seller (Ex-works, Factory, Watertown, Massachusetts. INCOTERMS); provided, however, that this warranty applies only to equipment found to be so defective within a period of 24 months from the date of manufacture by the Seller (36 months for the Spectra 12 and One Series products; 18 months for Temperature Sensors). Seller shall not be obligated under this warranty for alleged defects which examination discloses are due to tampering, misuse, neglect, improper storage, and in any case where products are disassembled by anyone other than authorized Seller's representatives. EXCEPT FOR THE LIMITED WARRANTY OF REPAIR AND REPLACEMENT STATED ABOVE, SELLER DISCLAIMS ALL WARRANTIES WHATSOEVER WITH RESPECT TO THE PRODUCT, INCLUDING ALL IMPLIED WARRANTIES OF MERCHANTABILITY OR FITNESS FOR ANY PARTICULAR PURPOSE.

LIMITATION OF SELLER'S LIABILITY

Seller's liability to Buyer for any loss or claim, including liability incurred in connection with (i) breach of any warranty whatsoever, expressed or implied, (ii) a breach of contract, (iii) a negligent act or acts (or negligent failure to act) committed by Seller, or (iv) an act for which strict liability will be inputted to seller, is limited to the "limited warranty" of repair and/or replacement as so stated in our warranty of product. In no event shall the Seller be liable for any special, indirect, consequential or other damages of a like general nature, including, without limitation, loss of profits or production, or loss or expenses of any nature incurred by the buyer or any third party.

UE specifications subject to change without notice.

WirelessHART® is a registered trademark of
FieldComm Group.
FLEXsense™ is a trademark of United Electric
Controls Co.

UNITED ELECTRIC
CONTROLS

180 Dexter Ave., Watertown, MA 02472 USA
617 926-1000 Fax 617 926-2568
www.ueonline.com