



APPROVALS:
 CULUS LISTED
 CLASS I, DIVISION 1,
 GROUPS B, C & D
 CLASS II, DIVISION 1,
 GROUPS E, F & G
 CLASS III
 -50°C ≤ Tamb. ≤ +71°C
 CLASS I, ZONE 1, GROUP IIB + H₂ T6
 ENCLOSURE TYPE 4X, 7, 9

ATEX DIRECTIVE 94/9/EC
 II 2 G Ex d IIC T6
 II 2 D Ex tD A21 IP66 T+85°C
 Tamb = -40°C TO +75°C

CE COMPLIANT TO
 APPLICABLE DIRECTIVE(S)
 I & M SHEET IMT120

SPECIFICATIONS:
 UE TYPE: E122-13321
 CUSTOMER: U.E.C. ST'D.
 RANGE: 25 TO 325°F WITH OVERTEMPERATURE
 PROTECTION TO 375°F, BULB & 6' CAPILLARY.
 SWITCH: SPDT
 E/R: 22 AMP 480 VAC
 DIFFERENTIAL: 6°F MAX.
 REPEATABILITY: WITHIN ±1% (3°F) OF RANGE.
 CAPILLARY: 10 ft 304 st/st
 STORAGE AMBIENTS: -65 TO +160°F.
 OPERATING AMBIENTS: -65 TO +160°F.
 SET POINT MAY SHIFT AT EXTREMES OF
 AMBIENTS UP TO 2% OF RANGE FOR EACH
 50°F CHANGE IN AMBIENT TEMPERATURE
 FROM -40 TO +160°F.
 CALIBRATION ACCURACY: ±6°F BETWEEN LIMITS
 OF 150° TO 200°F INCREASING TO ±15°F
 BETWEEN THE LIMITS OF 25 TO 149°F &
 201° TO 325°F.

CONDITIONS UNDER WHICH TOLERANCES APPLY:
 A.) 6 INCHES CAPILLARY INSTALLED WITH BULB.
 B.) AMBIENT TEMPERATURE OF CONTROL HEAD
 & REMAINING CAPILLARY 60° TO 90°F
 POINTER TO BE SET @ MID RANGE FOR SHIPPING.

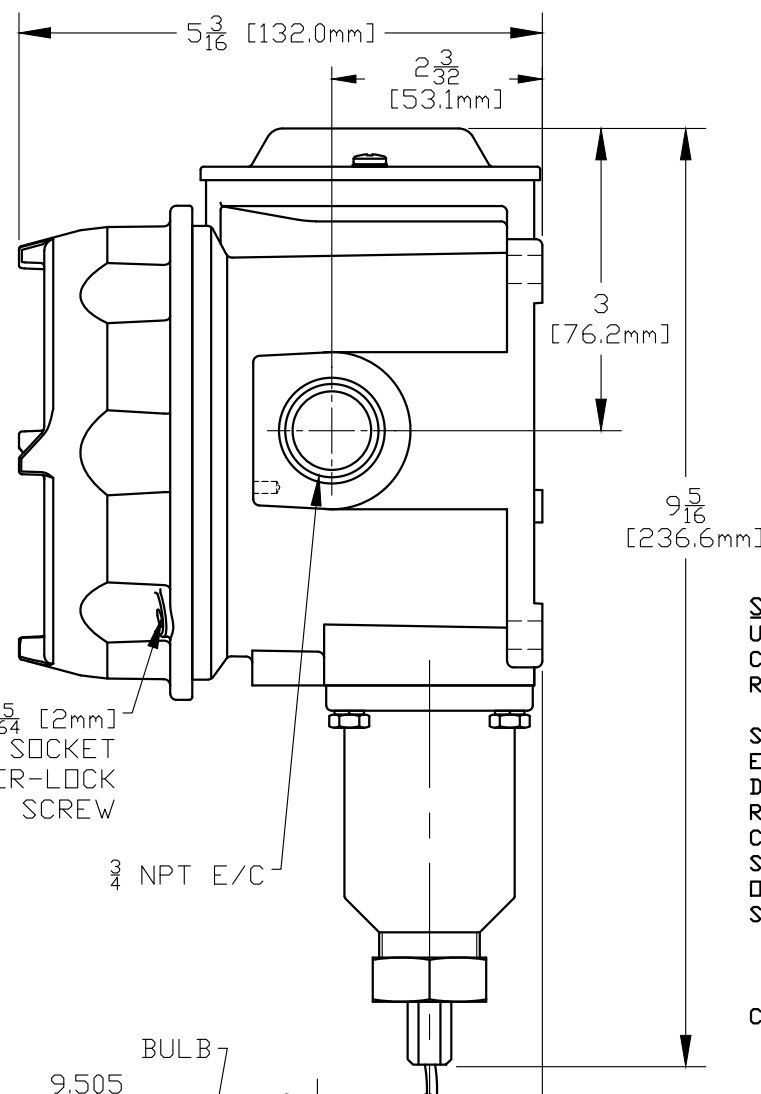
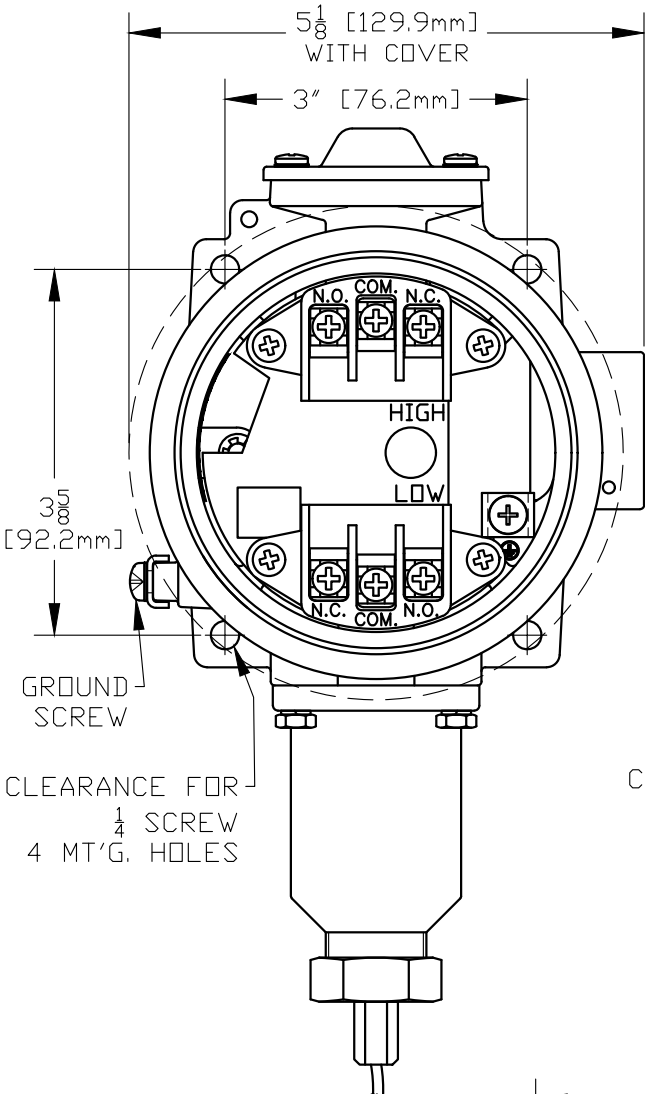

COVER REMOVED
 IN FRONT VIEW

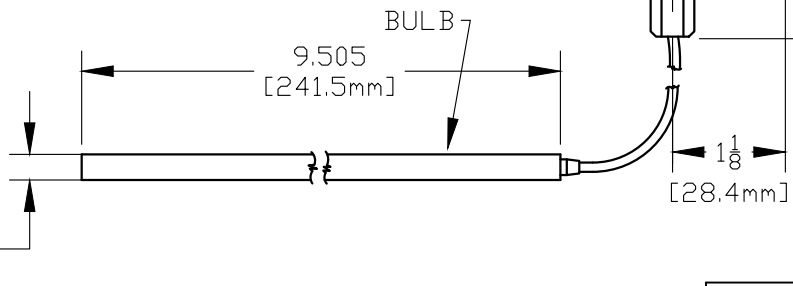

SYM	DESCRIPTION	DATE	DWN	APPD
C	SET POINT REMOVED ECN#E7482	4/29/24	KLF	RCI
B	UPDATED ENCLOSURE. ECN#E4345.	2-17-12	RCI	SJM
A	FIRST ISSUE. REPLACES SPEC. SHEET: 12145-1. ECN#E3275	8-11-09	S.R.	RAM
REVISIONS				

ORIGINAL DATE	8-11-09
DRWN	SR
CHKD	PLW
APPD	R. MCCAREY
UNLESS OTHERWISE SPECIFIED DIMENSIONS ARE IN INCHES	
DO NOT SCALE THIS DRAWING	

TITLE	E122-13321
UE STD HEATRACE	SCALE 1:2

DF001 REV. C
UE UNITED ELECTRIC CONTROLS COMPANY WATERTOWN * MASSACHUSETTS
DWG NO A-13951